

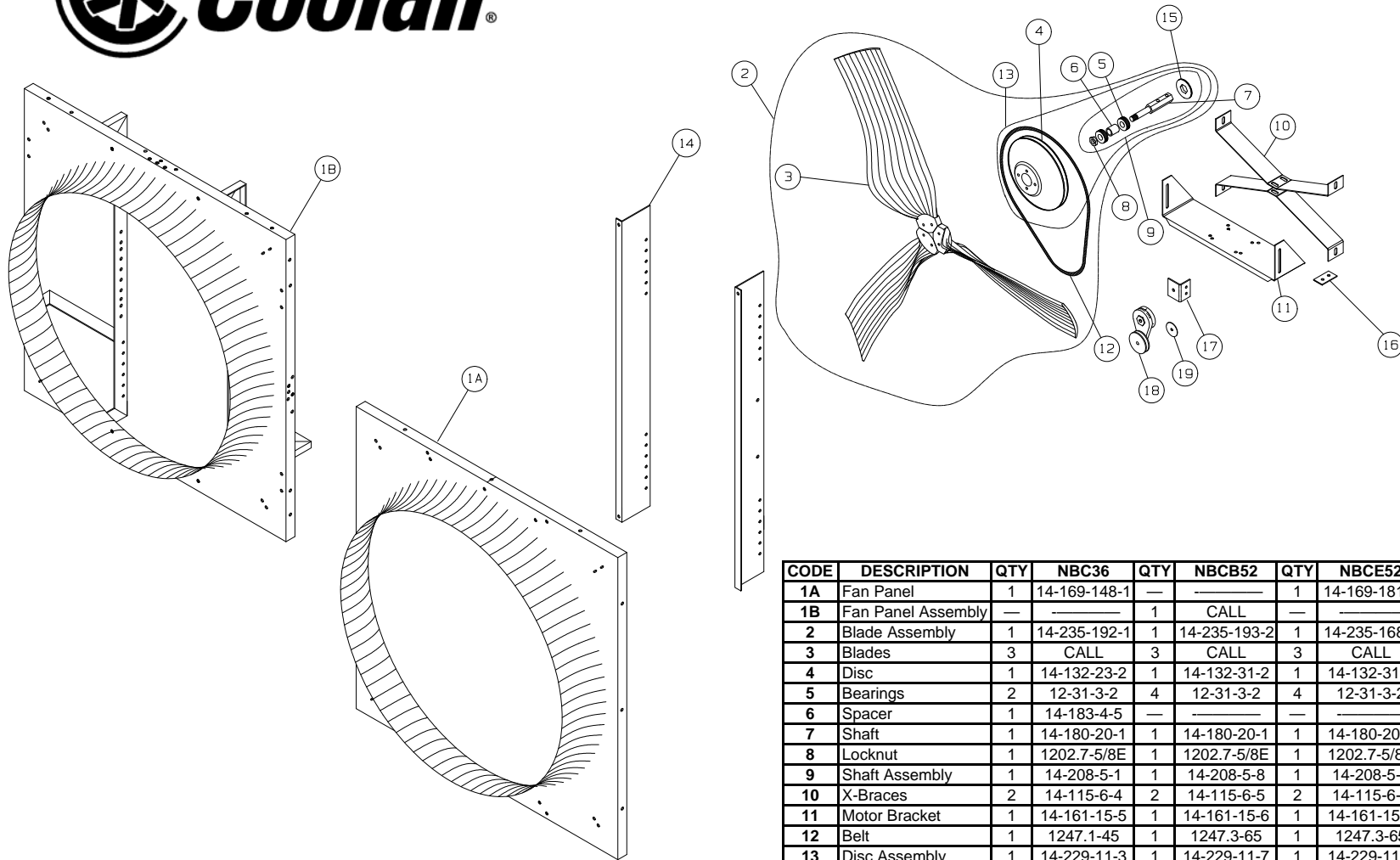

NBC36/NBCB52/NBCE52/NBC54 FAN PARTS LIST



CODE	DESCRIPTION	QTY	NBC36	QTY	NBCB52	QTY	NBCE52	QTY	NBC54
1A	Fan Panel	1	14-169-148-1	—	—	1	14-169-181-1	—	—
1B	Fan Panel Assembly	—	—	1	CALL	—	—	1	CALL
2	Blade Assembly	1	14-235-192-1	1	14-235-193-2	1	14-235-168-2	1	14-235-194-1
3	Blades	3	CALL	3	CALL	3	CALL	4	CALL
4	Disc	1	14-132-23-2	1	14-132-31-2	1	14-132-31-2	1	14-132-32-1
5	Bearings	2	12-31-3-2	4	12-31-3-2	4	12-31-3-2	4	12-31-3-2
6	Spacer	1	14-183-4-5	—	—	—	—	—	—
7	Shaft	1	14-180-20-1	1	14-180-20-1	1	14-180-20-2	1	14-180-20-1
8	Locknut	1	1202.7-5/8E	1	1202.7-5/8E	1	1202.7-5/8E	1	1202.7-5/8E
9	Shaft Assembly	1	14-208-5-1	1	14-208-5-8	1	14-208-5-7	1	14-208-5-8
10	X-Braces	2	14-115-6-4	2	14-115-6-5	2	14-115-6-5	2	14-115-6-7
11	Motor Bracket	1	14-161-15-5	1	14-161-15-6	1	14-161-15-6	1	14-161-15-7
12	Belt	1	1247.1-45	1	1247.3-65	1	1247.3-65	1	1247.3-69
13	Disc Assembly	1	14-229-11-3	1	14-229-11-7	1	14-229-11-9	1	14-229-11-8
14	Uprights	2	14-193-86-2	—	—	2	14-193-86-1	—	—
15	Bearing Protector	1	12-174-62-2	1	12-174-62-2	1	12-174-62-2	1	12-174-62-2
16	Shim	—	—	1	14-160-103-1	1	14-160-103-1	1	14-160-103-1
17	Tensioner Bracket	1	14-158-68-1	1	14-158-68-1	1	14-158-68-1	1	14-158-74-1
18	Tensioner	1	1258.12-6	1	1258.12-6	1	1258.12-6	1	1258.12-6
19	Bearing Protector	1	14-126-79-1	1	14-126-79-1	1	14-126-79-1	1	14-126-79-1
20	Vinyl Plug	—	—	1	1238.29	1	1238.29	1	1238.29